

**REPRODUCTION  
COPY**  
IS-4 REPORT SECTION

*Generation of Ultra-High  
Magnetic Fields for AGEX*

LOS ALAMOS NATIONAL LABORATORY  
  
3 9338 00296 5688

**Los Alamos**  
NATIONAL LABORATORY

*Los Alamos National Laboratory is operated by the University of California  
for the United States Department of Energy under contract W-7405-ENG-36.*

*Edited by Patricia W. Mendius, CIC-1  
Prepared by Clara DeMaria, X-DO*

*An Affirmative Action/Equal Opportunity Employer*

*This report was prepared as an account of work sponsored by an agency of the United States Government. Neither The Regents of the University of California, the United States Government nor any agency thereof, nor any of their employees, makes any warranty, express or implied, or assumes any legal liability or responsibility for the accuracy, completeness, or usefulness of any information, apparatus, product, or process disclosed, or represents that its use would not infringe privately owned rights. Reference herein to any specific commercial product, process, or service by trade name, trademark, manufacturer, or otherwise, does not necessarily constitute or imply its endorsement, recommendation, or favoring by The Regents of the University of California, the United States Government, or any agency thereof. The views and opinions of authors expressed herein do not necessarily state or reflect those of The Regents of the University of California, the United States Government, or any agency thereof.*

*Generation of Ultra-High  
Magnetic Fields for AGEX*

*Maurice G. Sheppard  
C. Max Fowler  
Bruce L. Freeman*



**Los Alamos**  
NATIONAL LABORATORY

Los Alamos, New Mexico 87545

# GENERATION OF ULTRA-HIGH MAGNETIC FIELDS FOR AGEX

by

Maurice G. Sheppard, C. Max Fowler, and Bruce L. Freeman

## ABSTRACT

Generation of ultra-high magnetic fields of 10-25 MG (0.4-2.5 MJ/cm<sup>3</sup>) using high-explosive-driven magnetic flux-compression is one approach which could enhance the U.S. Above Ground EXperimental (AGEX) capability. The beginnings of a U.S.-Russian collaboration to generate 20 MG by extending flux-compression technology are described. The first joint experiments, planned for November 1993 at Los Alamos, will test the Russian MC-1 10 MG generator and will be followed by several high-temperature superconductor experiments. Equation-of-state experiments involving isentropic compression at pressures of several megabars are being considered as follow-on joint experiments. Magneto-hydrodynamic (MHD) calculations of the MC-1 experiments using the 1D MHD code RAVEN are presented, including comparisons and benchmarks against previous Russian experiments and calculations. The first joint experiments will use Russian hardware and U.S. high-explosive. Gaining practical experience with the MC-1 and benchmarking the RAVEN predictions for the performance of the modified generator are important first steps towards reaching the 20 MG goal.

---

## Introduction

Energy densities associated with magnetic fields of 10-25 MG (0.4-2.5 J/cm<sup>3</sup>) represent a potential energy source for Above Ground EXperiments (AGEX). Possible relevant uses for ultra-high magnetic fields include magnetically driven liner implosions for x-ray production, adiabatic (isentropic) compression of materials at pressures exceeding 10 Mb for equation-of-state studies, neutron production through fusion plasma confinement or compression, and high-power microwave production.

Scientists from Los Alamos National Laboratory and the Russian nuclear weapons laboratory

at Arzamas-16 are collaborating on ultra-high magnetic field experiments using explosive pulsed power. This collaboration, made possible for the first time by the end of the Cold War, will allow the scientific exchange of unclassified knowledge, data, and experience which has been inaccessible to the general scientific community because of its proximity to each country's nuclear weapons program. The first series of experiments will use the Russian MC-1 flux-compression generator (FCG), designed and perfected by the late A. I. Pavlovskii and his colleagues.<sup>1</sup> The MC-1 was assembled with U.S. high-explosives (HE) and diagnostics to measure the upper critical field transition,

Hc<sub>2</sub>(T), of the high-temperature superconductor (HTSC), YBa<sub>2</sub>Cu<sub>3</sub>O<sub>7</sub> (YBCO), at temperatures of 4 K and higher. Experiments should commence in November 1993 at Los Alamos.

The scope of this paper is limited to a presentation of 1D MHD simulations of the MC-1 with the Lagrangian RAVEN code; this paper is not intended to be a complete report of the U.S.-Russian collaboration. A general discussion of ultra-high magnetic field generation in the next section is followed by a description of the MC-1 FCG and a review of the Russian experience with this generator. The fourth section gives details of RAVEN calculations with different types of HE and varying initial fields. These calculations are compared with Russian calculations and experimental results. Preshot calculations for the HTSC experiments and possible isentropic compression experiments for equation-of-state studies are also included.

### Generation of Ultra-High Magnetic Fields

Generating 10 MG magnetic fields, or greater, in volumes large enough for diagnostics and macroscopic experiments presents special challenges associated with high energies, high energy densities, very large magnetic pressures, and magnetic induced plasma instabilities. The primary mechanism for creating such fields is explosively-driven magnetic flux-compression. A seed field is first generated and trapped in a volume which is surrounded by electrical conductors. Then, a conducting armature, driven by HE, wipes out the volume while doing work against the trapped field -- thus amplifying it. An excellent review of flux-compression fundamentals appears in Fowler, Caird, and Garn.<sup>2</sup>

To illustrate the magnitude of the challenge presented by ultra-high fields, consider the following discussion. The energy density associated with 10 MG is 0.4 MJ/cm<sup>3</sup>, whereas the chemical energy released upon HE detonation is only 9 x 10<sup>-3</sup> MJ/cm<sup>3</sup>. Furthermore, the magnetic pressure associated with 10 MG is 4 Mb -- an order of magnitude above typical HE pressures. Since energies and pressures scale as the square of the magnetic field, the difficulty of

the task and the richness of the payoff skyrocket with higher fields. The trick is to efficiently convert large amounts of HE chemical energy into kinetic energy of an armature. The armature must then wipe out the high inductance volume in a short enough time that the trapped magnetic field neither diffuses out of nor destroys its confining walls. At the 10 MG level, and slightly higher, the Russian scientists at Arzamas-16 have demonstrated repeatable and reliable performance with the MC-1.<sup>3,4</sup>

### MC-1 Description

A diagram of the Russian three-cascade MC-1 FCG is presented in Fig. 1. The HE cylinder, which in the Russian experiments has been composed of a 50/50 RDX/TNT mix, is detonated simultaneously on its outer diameter surface by a ring of 10 polystyrene block initiators.

Inside the HE are 3 concentric cylindrical shells (known as cascades in the Russian literature), made of a unique copper-epoxy composite. These shells successively take on the role of armature during implosion. The shells are made of hundreds of 0.25-mm diameter, enamel-coated, copper threads arranged side-by-side in layers and secured in a casting of epoxy. The 500 copper threads of the outer cascade are wound in a 2-turn solenoid and then brought back along the outside diameter, parallel with the cylindrical axis, to complete the return current path. The solenoid cascade is impregnated with epoxy and cured. The outside diameters of all 3 cascades, which are cast with a thicker layer of epoxy, are machined smooth to inhibit hydrodynamic instabilities. An initial magnetic field of up to 220 kG (typically 130-160 kG) is created by discharging a capacitor through the first cascade. The discharge is timed so that peak field is achieved just as the HE detonation wave reaches the first cascade. Upon contact the HE shock breaks down the insulation between the solenoid threads and transforms the first cascade into a conducting cylinder -- trapping and then compressing the initial field as the shell begins to move.

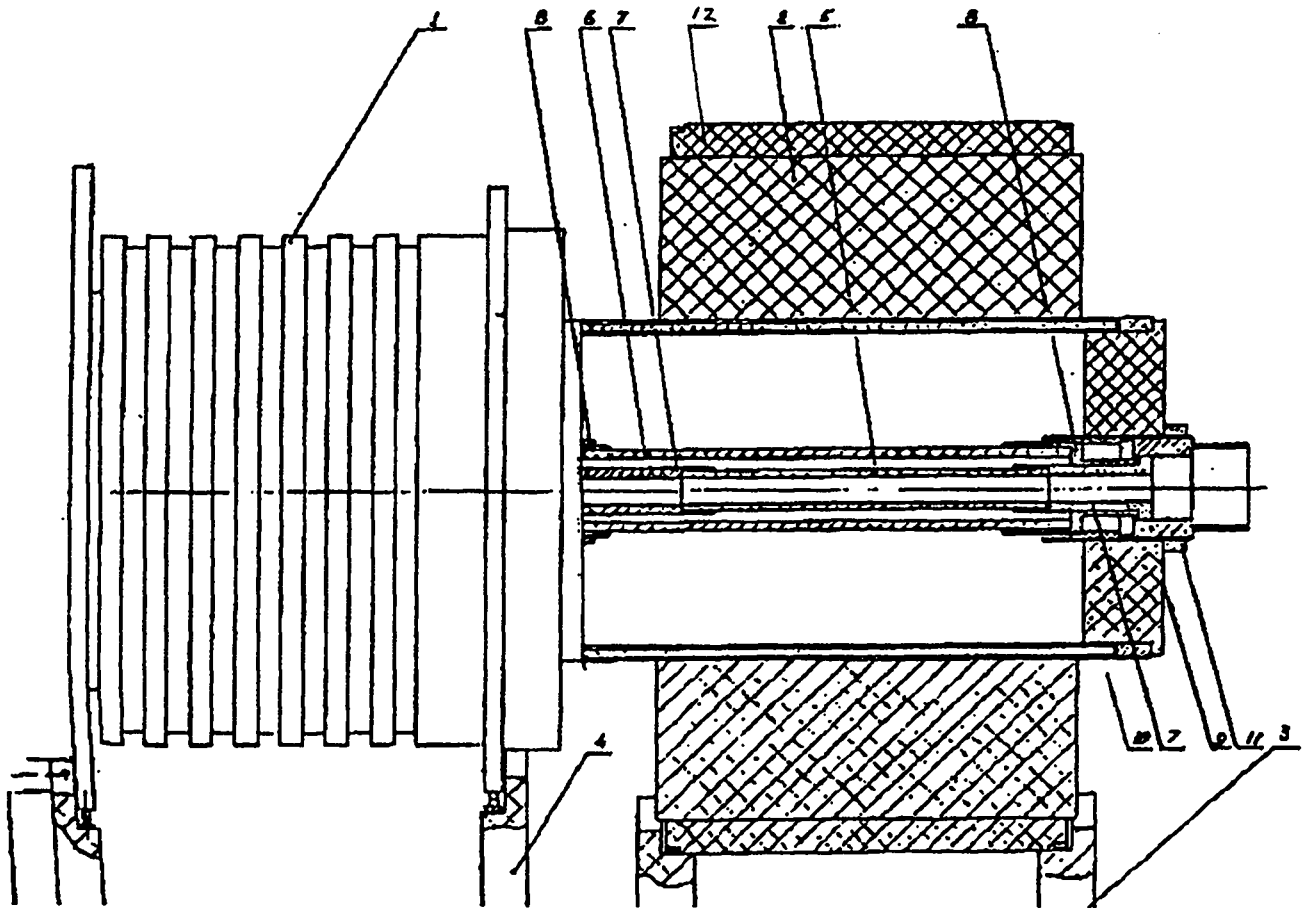

Fig. 1. Russian 3-cascade MC-1 FCG. Labels are identified as follows: 1 - insulated current feed for solenoid; 2 - explosive charge; 3, 4 - support stands; 5 - 3rd cascade; 6 - 2nd cascade; 7, 8, 9 - insulating foam assembly cradles for cascades; 10 - solenoid; 11 - assembly nut; 12 - initiator

The second and third cascades are similarly constructed except that all of the copper threads are laid parallel to the axis. Before a cascade is contacted and shocked from outside, it will only conduct current in the axial direction. Hence, it is transparent to the axial field which is being compressed by the preceding shell. On contact, however, the cascade is transformed by the shock into a conducting cylinder, which traps the field inside as the new cascade becomes the new armature.

The use of multiple cascades serves two important functions. The first benefit of multiple

cascades is the velocity enhancement which is derived from collisions of heavy outer shells with lighter inner shells. The second (and more crucial) benefit is related to implosion stability. As the outer cascade compresses flux, magnetic and hydrodynamic instabilities tend to disrupt the shell. These instabilities are made worse by the inherent perturbations associated with the copper-epoxy composite. The inner cascades are strategically placed to recollect and smooth out the perturbations before the outer cascade is disrupted. The loss of flux which is incurred during the transition is offset by achieving a more stable and reproducible implosion.

In the early systems developed by Fowler, Garn, and Caird,<sup>5</sup> initial field coils were also placed under the explosive charge. While very large fields were obtained (up to 14 MG), performance was erratic. The use of additional Pavlovskii cascades would presumably have led to better reproducibility. An alternative approach to controlling the instabilities was investigated by Caird et al.<sup>6,7</sup> They placed the solenoid outside of the HE and used a single stainless steel armature. On the timescales of the initial capacitor discharge, the stainless steel armature allowed magnetic flux to diffuse inside the cylinder; but on the short timescale of the implosion, the flux was essentially trapped and compressed. However, the poorer coupling of the initial coils with the armature results in substantially lower initial, and, therefore, also final compressed fields.

### Details for the First Experimental Series

The first of 5 tests of the MC-1 will be a proof test of the 3-cascade generator using COMP-B HE instead of the Russian 50/50 mix. COMP-B is slightly more energetic by virtue of its 60/40 RDX/TNT composition. The generator will be preloaded to 160 kG using the capacitor bank at Point 88 in Ancho Canyon. Assuming successful validation of the MC-1 performance in the first shot, the next 3 tests are designed to measure the critical field transition of YBCO. Finally, if everything goes as planned, the last experiment of this series will be another test of the 3-cascade system using PBX-9501 -- a dramatically higher energy HE. Results of these tests will be compared with the preshot calculations described in the next section. Benchmarking of the RAVEN code at these high fields is a first step towards pursuing the 20 MG goal.

In the HTSC experiments, the third cascade will be removed, and the volume inside the second cascade will be occupied by a 0.15 g/cm<sup>3</sup> foam cryostat. The YBCO sample, which occludes a 4-mm dielectric microwave waveguide, and Faraday rotation diagnostics will be bathed in liquid helium via channels in the foam. As the field strength increases during the

compression, the YBCO film will undergo the H<sub>c2</sub> transition and become resistive. Before the transition occurs, 94 GHz diagnostic microwaves, which will be focused into one end of the waveguide, will be largely reflected by the superconducting film. After the transition, the microwaves will be increasingly transmitted and detected.

### 1D MHD RAVEN Calculations

Simulations of the MC-1 have been conducted with the 1D Lagrangian MHD code RAVEN utilizing SESAME equations of state (EOS) and electrical conductivities.<sup>8,9</sup> Cascades were modeled as sandwiched layers of copper and epoxy. The number of layers used for each cascade matches the actual number of layers of copper thread in each cascade, and the thickness of the layers was adjusted to match the reported average density of each cascade while fixing the total sandwich thickness. This approach differs from the Russian computational models,<sup>3</sup> which use a mixed copper-epoxy EOS and only one layer per cascade shell. The Russians scaled a standard copper resistivity model by a factor of 5 to use for the mixed EOS. The RAVEN calculations treated each copper shell with an unscaled resistivity and each epoxy layer as an insulator. To allow the axial magnetic field to pass freely through the cascades until they were shocked in the calculations, the standard copper resistivity in each zone was multiplied by a step function which remained zero until the zone density first exceeded 1% above normal density; subsequently the step function stayed equal to one for the remainder of the simulation.

### 3-Cascade MC-1 Simulations

Calculations of the 3-cascade MC-1 with an initial field of 160 kG were done with JWL HE models for the 50/50 mix, COMP-B and PBX-9501. Radius vs. time plots for the cascade interfaces, from the 50/50 mix calculations, are shown in Fig. 2. Plots of the on-axis field vs. time are shown in Fig. 3 for these calculations.

Similar Russian calculations and experimental results from one test are also compared with our calculation in Fig. 3. The measured peak field for the 50/50 mix, averaged over 100's of tests, is reported as  $9.5 \pm 0.5$  MG,<sup>10</sup> which is in excellent agreement with the RAVEN simulation. The Russian calculation underestimates the measured peak field. Using higher energy explosives, like COMP-B and PBX-9501, gives a higher peak field by transferring more kinetic energy (velocity) to the cascades but at the expense of a smaller minimum radius. Peak fields predicted for 50/50, COMP-B, and PBX-9501 are 10 MG, 11 MG, and 13.5 MG while the radii at which the inner surfaces of the third cascade are stopped by the compressed field are 4.4 mm, 4.2 mm, and 3.6 mm respectively. The combination of higher velocity and higher peak field, coming from the use of more energetic HE, results in significantly higher time derivatives for the field. For the 50/50 mix, RAVEN pre-

dicts a derivative of  $12.5$  MG/ $\mu$ s, whereas the prediction for PBX-9501 is a factor of 2 higher.

Operation of the MC-1 is illustrated in Figs. 4-6, which show various quantities as a function of radius at 3 different times for the COMP-B simulation. Figure 4 shows density and magnetic field of the second and third cascades at  $21 \mu$ s, before the outer cascade has made contact. Note the alternating copper and epoxy layers in the cascades and their transparency to the magnetic field. At  $23.5 \mu$ s, Fig. 5 shows the second cascade already turned into a conductor, moving at  $5.5$ -mm/ $\mu$ s and compressing the field through the still transparent third cascade. Finally at  $24.6 \mu$ s, in Fig. 6, the third cascade is beginning to be slowed by the magnetic back-pressure on-axis. Notice that between the two cascades, the magnetic field is acting as a staging fluid to continuously transfer kinetic energy from the second to the third cascade while keeping them somewhat separated.

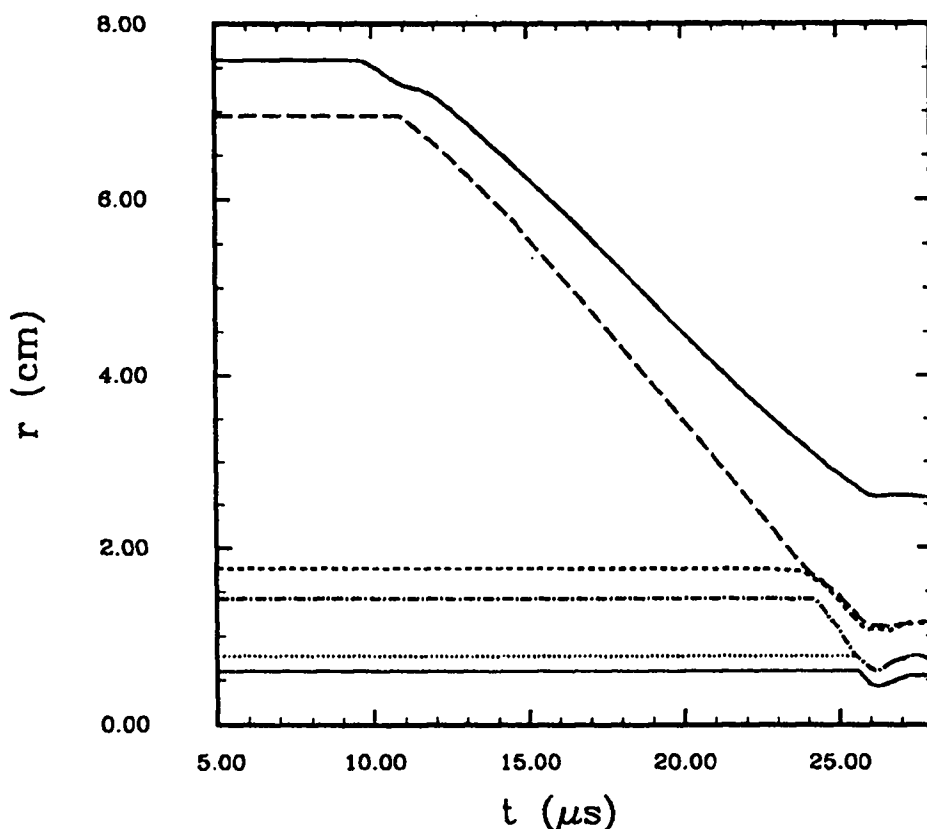

Fig. 2. Cascade interface positions from the RAVEN simulation of a 3-cascade MC-1 driven by 50/50 mix HE. Time is relative to HE detonation.



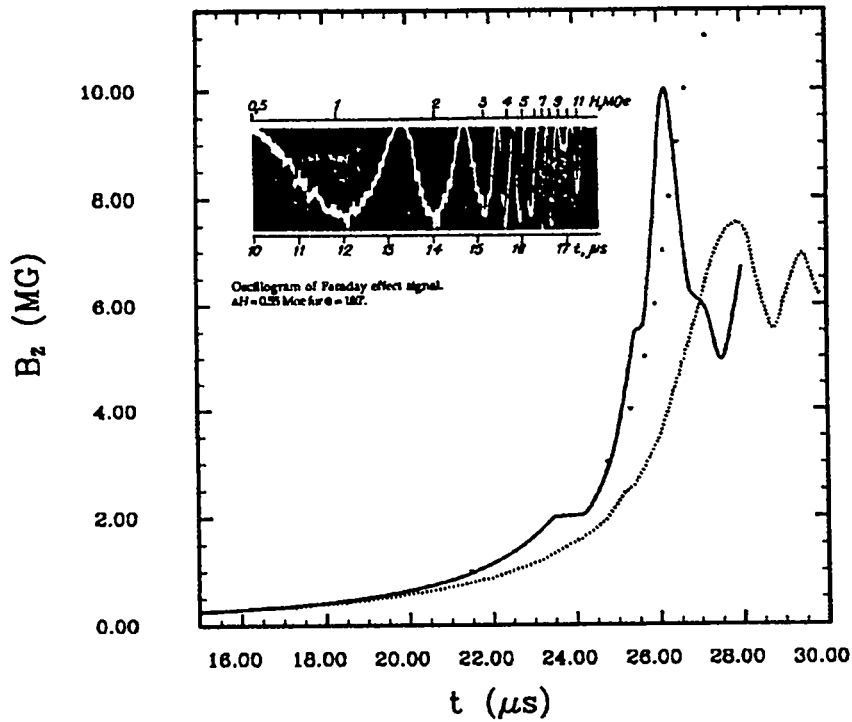

Fig. 3. Axial magnetic field for 3-cascade MC-1 with 160 kG initial field. The solid line is from the RAVEN simulation of Fig. 2, the dotted line is from ID Russian simulations provided by Dolotenko, and the points are experimental data from Ref. 1.

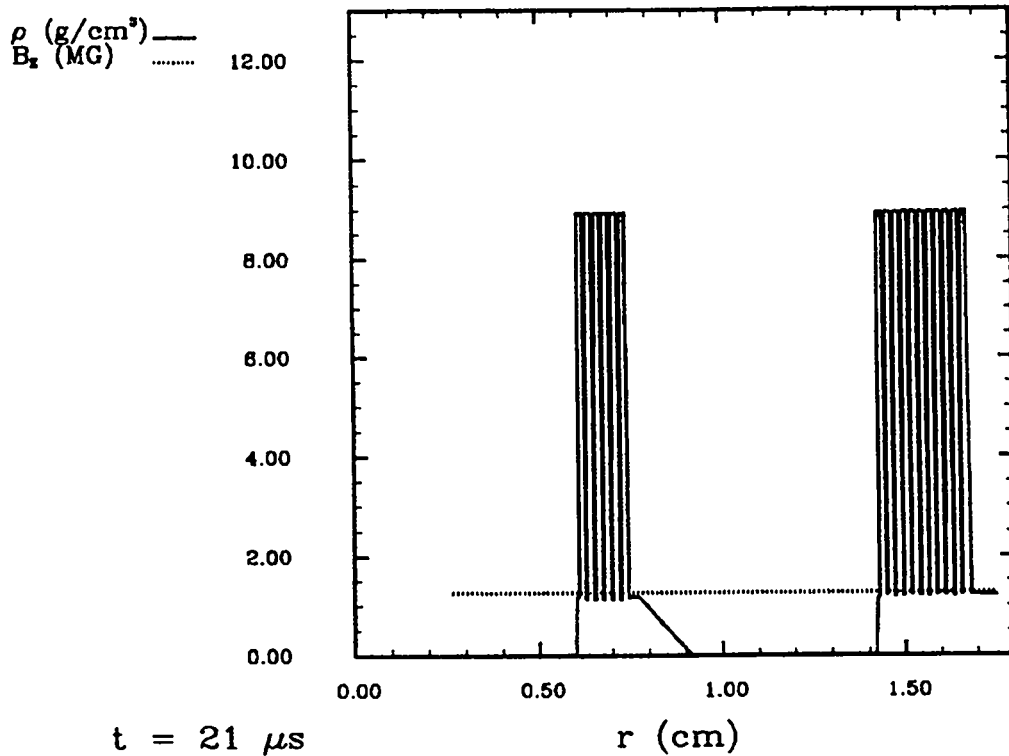

Fig. 4. Density and magnetic field profiles through the 2nd and 3rd cascades from RAVEN simulations of the MC-1 driven by COMP-B at 21  $\mu s$  after HE detonation.

Another way to achieve higher fields (up to a point) in the MC-1, is to use a smaller initial field. This change allows the armature to implode further before the field gets high enough to stop and turn it around. This has the effect of raising the time-derivative of the field and reducing the central field volume. If the initial field gets too small, the integrity of the central volume is destroyed by instabilities, or the diagnostics are destroyed before peak field is reached. Calculations with COMP-B at initial fields of 160 kG, 130 kG, and 100 kG predicted

peak fields of 11 MG, 12 MG and 13.2 MG with minimum radii of 4.2 mm, 3.7 mm, and 3.2 mm, respectively.

### 2-Cascade MC-1 Simulations

Simulations of the 2-cascade MC-1 were done with COMP-B and a  $0.15 \text{ g/cm}^3$  polystyrene cryostat in preparation for the HTSC experiments. Figure 7 shows selected Lagrangian zone boundaries in the cryostat plotted with the predicted magnetic field and its derivative. The

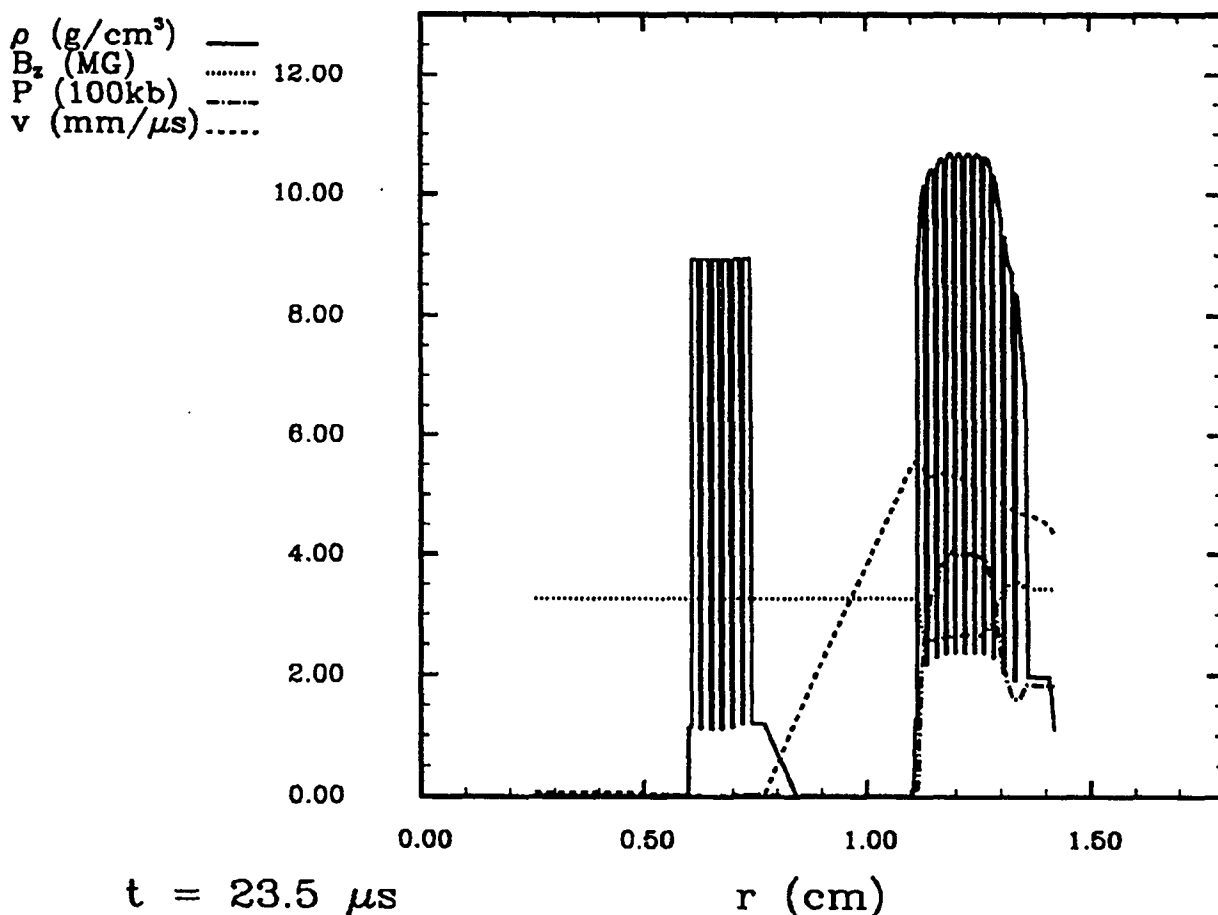

Fig. 5. Profiles through the 2nd and 3rd cascades from RAVEN simulations of the MC-1 driven by COMP-B at  $23.5 \mu\text{s}$  after HE detonation.

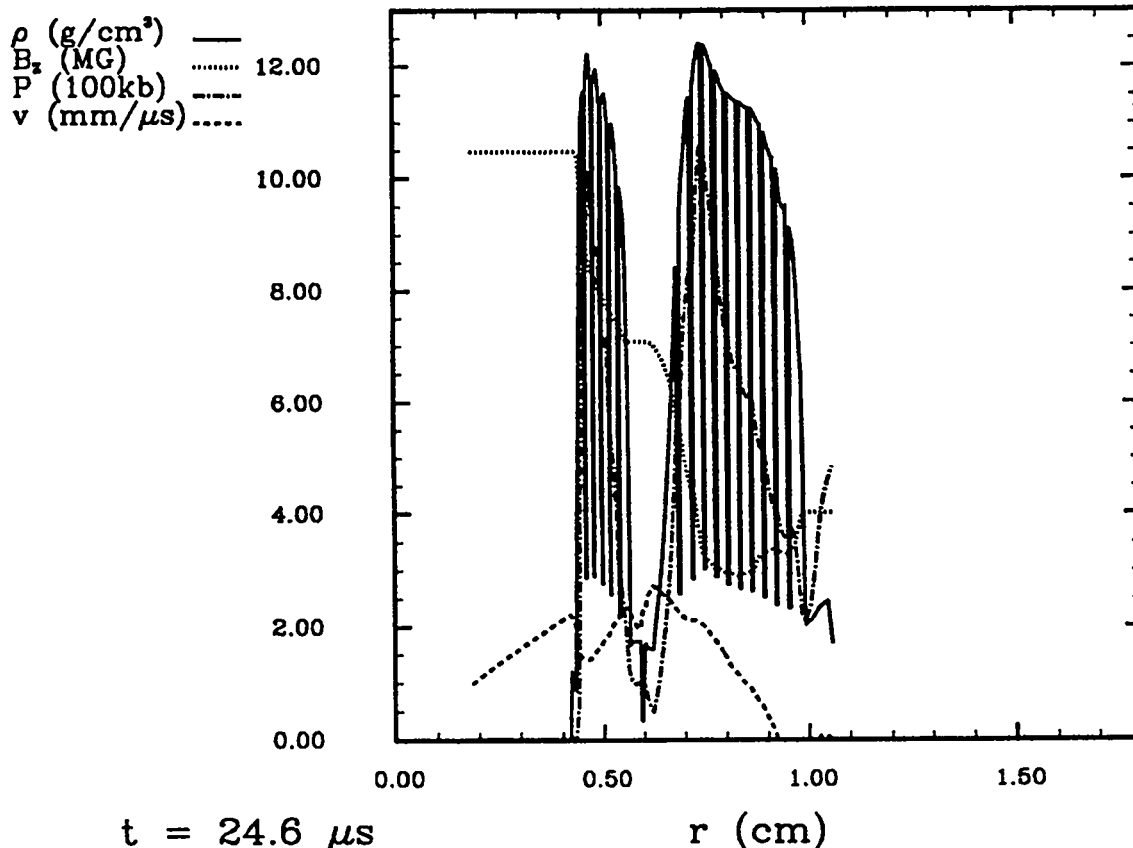

Fig. 6. Profiles through the 2nd and 3rd cascades from RAVEN simulations of the MC-1 driven by COMP-B at 24.6  $\mu$ s after HE detonation.

experimental volume required to contain the YBCO film, dielectric waveguide, and field diagnostics is 6 mm in radius. Figure 8, taken from the same simulation, shows the zone boundary nearest 6 mm with the zonal density, pressure, and velocity plotted on the same graph as the field and its derivative. RAVEN predicts that the MC-1 should produce 5 MG before destructive signals reach the 6 mm level. Unfortunately, this prediction must be considered optimistic because RAVEN cannot account for shell instabilities and azimuthal asymmetries which could easily generate signals that precede the 1D simulation estimate. Furthermore, accurately modeling the hydrodynamics of shocked foams (with 3D voids throughout) with a simple EOS is a difficult proposition.

### Simulations of Isentropic Compression Experiments using the MC-1

Isentropic compression experiments can potentially give valuable EOS data at high pressures and low temperatures. These conditions are reachable through magnetic compression of a cryogenically cooled capsule at the center of a high-field flux-compression system. A recent paper by Fowler et al.<sup>11</sup> surveys efforts in this area. In a system designed by Pavlovskii et al.<sup>12</sup> employing a 2-cascade MC-1, the cryostat consists of two concentric stainless steel tubes surrounding a tubular copper sample holder. The stainless steel tubes form channels for liquid helium. The central volume contains a

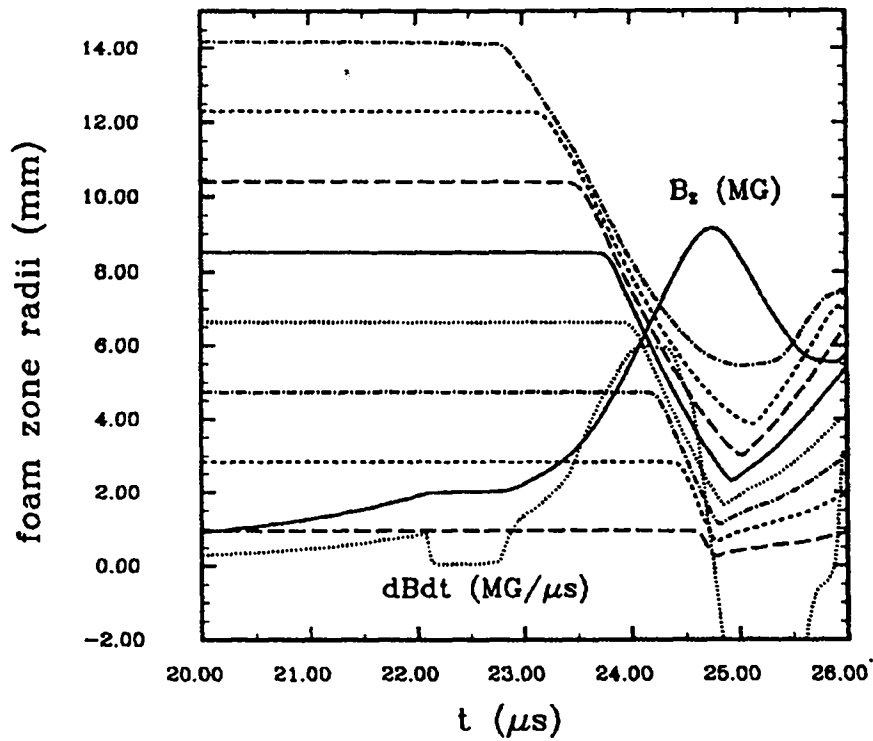

Fig. 7. Selected Lagrangian zone boundaries in the foam cryostat plus the magnetic field and its time derivative from a RAVEN simulation.

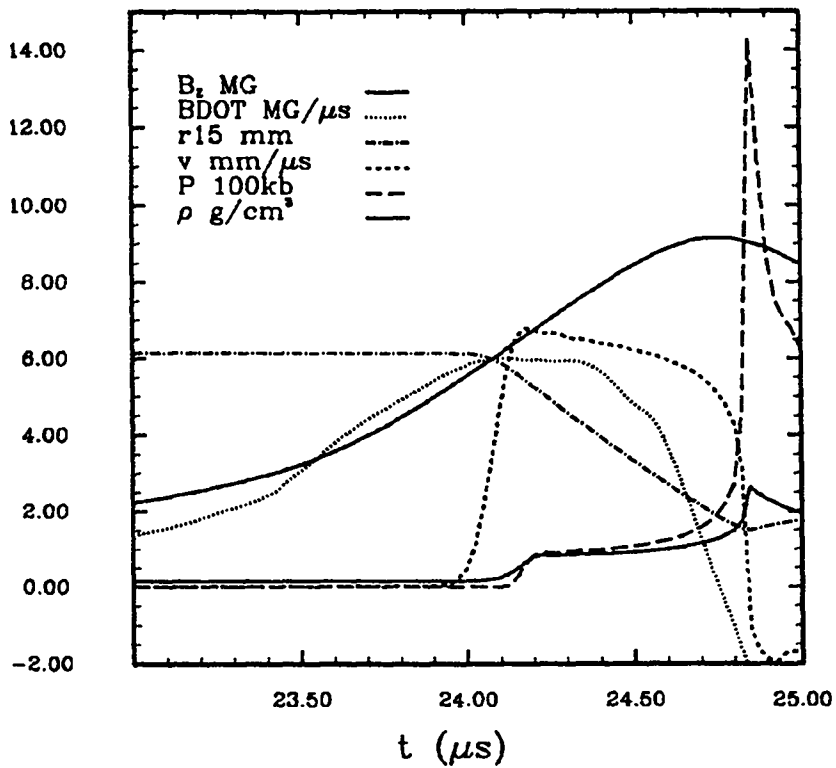

Fig. 8. Time history of the Lagrangian zone initially nearest 6-mm radius in the foam cryostat.

material sample — for instance, frozen deuterium or hydrogen. Only small magnetic fields penetrate through the cryostat to the sample during compression by megagauss fields. Figure 9, extracted from a RAVEN simulation, displays a 1D representation of a hydrogen-filled capsule implosion. Predicted peak pressure in the hydrogen exceeds 10 Mb; however, isentropic conditions are not perfectly maintained in the calculation.

### Summary

Collaborations with Russian scientists on the production of ultra-high magnetic fields provide three exciting opportunities. First, these (above

ground) experiments will access energy densities which are difficult to realize except in underground tests. Second, the Russian effort in this field is extensive. They have more people, more time, and more money invested in explosive pulsed power and high-field physics than anyone else in the world; we will benefit from their experience as a result of the collaboration. Finally (and this is a political statement reflecting the belief of the authors), the best way to deal with “enemies” is to convert them to friends; and the best way to become friends is to work together towards a mutually beneficial goal. Scientists from Los Alamos and Arzamas-16 will lead our respective countries towards friendship and a more stable peace through this endeavor.

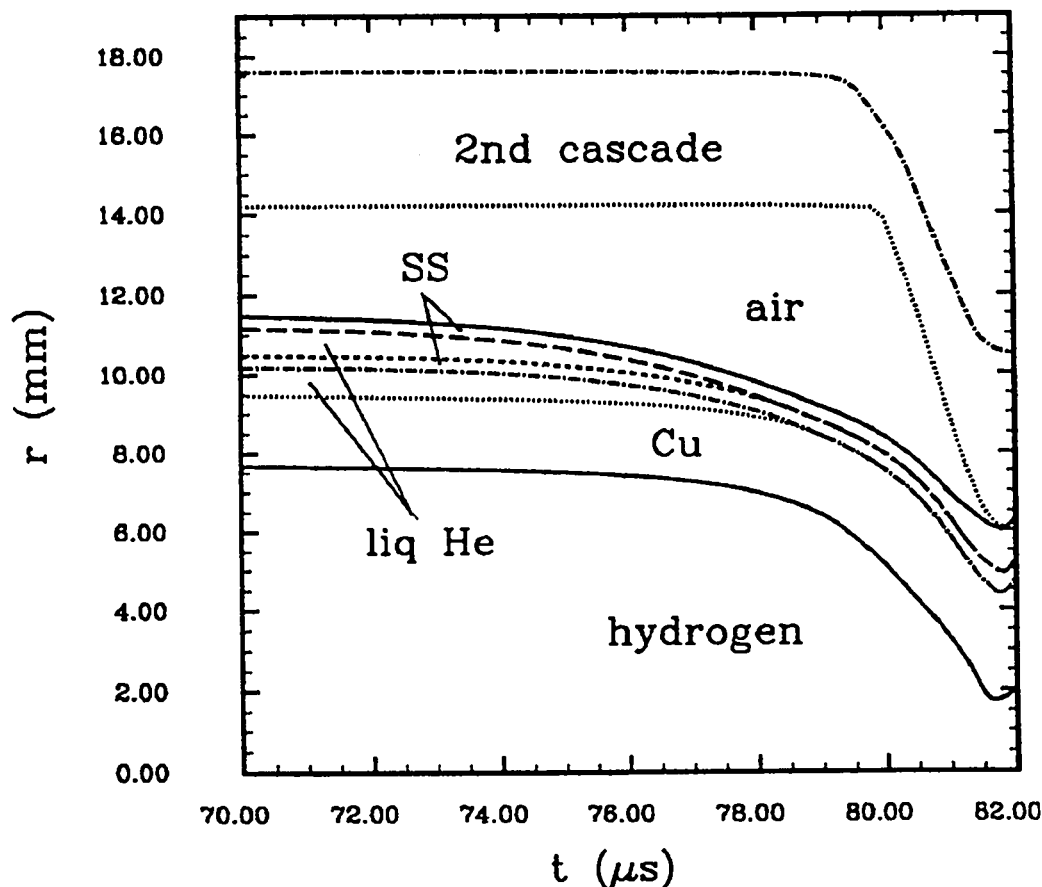

Fig. 9. Interface positions of 2nd cascade and central cryostatic sample container from RAVEN simulation of a possible isentropic compression experiment driven by COMP-B

## References

1. Pavlovskii, A. I., "Ultra-high Magnetic Fields Cumulation," in *Megagauss Fields and Pulsed Power Systems*, ed. by Titov, V. M. and Shvetsov, G. A., (Nova Science Publishers, Inc., New York, 1990), p. 1.
2. Fowler, C. M., Caird, R. S. and Garn, W. B., *An Introduction to Explosive Magnetic Flux Compression Generators*, Los Alamos Scientific Laboratory, Los Alamos, NM, UC-34, LA-5890-MS (1975).
3. Pavlovskii, A. I., Karpikov, A. A., Dolotenko, M. I., and Mamyshev, V. I., "Dynamic Characteristics Analysis of a Ultra-High Magnetic Field Cascade Magnetocumulative Generator (MC-1)," in *Megagauss Fields and Pulsed Power Systems*, ed. by Titov, V. M. and Shvetsov, G. A., (Nova Science Publishers, Inc., New York, 1990), p. 21.
4. Pavlovskii, A. I., Kolokolchikov, N. P., Dolotenko, M. I., Bykov, A. I., Karpikov, A. A., Mamyshev, V. I., Spirov G. M., Tatsenko, O. M., Markevtsev, I. N., and Sosnin, P. V., "Production of 15-MG Magnetic Fields in Cascade Ultrahigh Field Generators (MC-1)," in *Megagauss Fields and Pulsed Power Systems*, ed. by Titov, V. M. and Shvetsov, G. A., (Nova Science Publishers, Inc., New York, 1990), p. 29.
5. Fowler, C M., Garn, W. B. and Caird, R. S., "Production of Very High Fields by Implosion," *J. Appl. Phys.*, **31**, 588 (1960).
6. Caird, R. S., Garn, W. B., Thomson, D. B. and Fowler, C. M., "An Explosive-Driven High-Field System for Physics Applications," *J. Appl. Phys.*, **35**, 781 (1964).
7. Caird, R. S., Garn, W. B., Thomson, D. B. and Fowler, C. M., "A Cylindrical Explosive Flux-Compression System," in proceedings of the Conference on Megagauss Magnetic Field Generation by Explosives and Related Experiments, (Frascati, Italy, September 21-23, 1965), p. 101.
8. More, R. M., Lawrence Livermore National Laboratory, Livermore, CA, UCRL-84991 (March 1981).
9. Lee, Y. T. and More, R. M., *Phys. Fluids*, **27**, 1273 (1984).
10. Pavlovskii, A. I., Bykov, A. I., Dolotenko, M. I., Karpikov, A. A., Kolokolchikov, N. P., Mamyshev, V. I., and Tatsenko, O. M., "Limiting Value of Reproducible Magnetic Field in Cascade Generator MC-1," in *Megagauss Technology and Pulsed Power Applications*, ed. by Fowler, C. M., Caird, R. S., and Erickson, D. J., (Plenum Press, New York, 1987), p. 159.
11. Fowler, C. M., Caird, R. S., Edeskuty, F. J., Lund, C. M. and Mills, R. L., "Nearly Isentropic Compression of Materials by Large Magnetic Fields: A Survey," in *Proceedings of the International Symposium on Intense Dynamic Loading and its Effects*, (Sichuan University Press, Chengdu, China, 1992).
12. Pavlovskii, A. I., Karpikov, A. A., Mamyshev, V. I., Bykov, A. I., Dolotenko, M. I. and Egorov, N. I., "Analysis of Metal Tube Compression by Ultra-high Magnetic Field Pressure in Cascade MC-1 Generators," in *Megagauss Fields and Pulsed Power Systems*, ed. by Titov, V. M. and Shvetsov, G. A., (Nova Science Publishers, Inc., New York, 1990), p. 163.

This report has been reproduced directly from the best available copy.

It is available to DOE and DOE contractors from the Office of Scientific and Technical Information, P.O. Box 62, Oak Ridge, TN 37831. Prices are available from (615) 576-8401.

It is available to the public from the National Technical Information Service, US Department of Commerce, 5285 Port Royal Rd., Springfield, VA 22161.

**Los Alamos**  
NATIONAL LABORATORY

Los Alamos, New Mexico 87545